



PRODUCT INFORMATION & INSTALLATION GUIDE 2021

Airius Model G400/EC
SAPPHIRE SERIES

www.airius.com.au

AIRIUS[®]
Airflow Reinvented

MODEL G400/EC DIMENSIONS AND PROPERTIES



UNIT SIZE	STANDARD
Weight:	13.60 kgs
Height to Rim:	N/A
Total Height:	340 mm
Diameter:	495 mm
MOTOR	230V @ 50 Hz
Watts*:	390
RPM*:	1660
L/S*:	1561
m ³ /hr:	5620
Centre Line Velocity ¹ :	2.79 m/s @ 10 m
AMPS*:	2.24
Thrust*:	14.32 Newtons

*Motor data provided by motor manufacturer and is subject to change at anytime
¹Velocity profile tested in situ

COVERAGE	COOLING	HEATING
Ceiling Height	= 8m - 11m	= 10m - 16m
Floor area	= Up to 120m ²	= Up to 250m ²

All data is indicative only and can change subject to application. For more accurate design please contact Airius Oceania

MOTOR
Single Phase
Electrically commutated, variable speed 92% efficient motor
German EBM Papst EC motor
230 Volt @ 50/60 Hz

OPERATING TEMPERATURES	
Min start temp (approx.)	= - 10° C
Min running temp	= - 25° C
Shut off	= 135° C
Reset	= 125° C

HOUSING
PC/ABS Resin - Inc. internal fixed blade stator
5VA flame resistance rating
1.8m steel safety leash cable (fastened to housing)

INGRESS PROTECTION
IP54 Rated

NOISE LEVELS	
Sound Power Level	= 80 dB(A)
Sound Pressure Level @ 3 mts	= 60 dB(A)
Sound Pressure Level @ 6 mts	= 53 dB(A)
Sound Pressure Level @ 10 mts	= 49 dB(A)

Note: A typical free field environment over a reflecting plane.
 All acoustic testing conducted at 230 Volt, 50Hz and undertaken at the EBM- Papst Acoustic Laboratories in Connecticut USA during August 2014

Please contact Airius for full Noise Testing Report

COLOUR
Off-White, Black or Grey available

ACCESSORIES & OPTIONS
Multiple speed control options available: <ul style="list-style-type: none"> - Full 0-100% potentiometer speed control option - Fully programmable Airius touch screen controller - Airius PearLink WiFi Control
Fully BMS controllable
Bacnet Protocol option for individual fan control
For horizontal installations Airius recommend the use of the Airius proprietary cradle or a second cable or rod attachment to the discharge end to provide balance

WARRANTY
5 years full manufacturers replacement from date of despatch. Subsequent 5 year 'half new price' rebuild cover

VELOCITY PROFILE

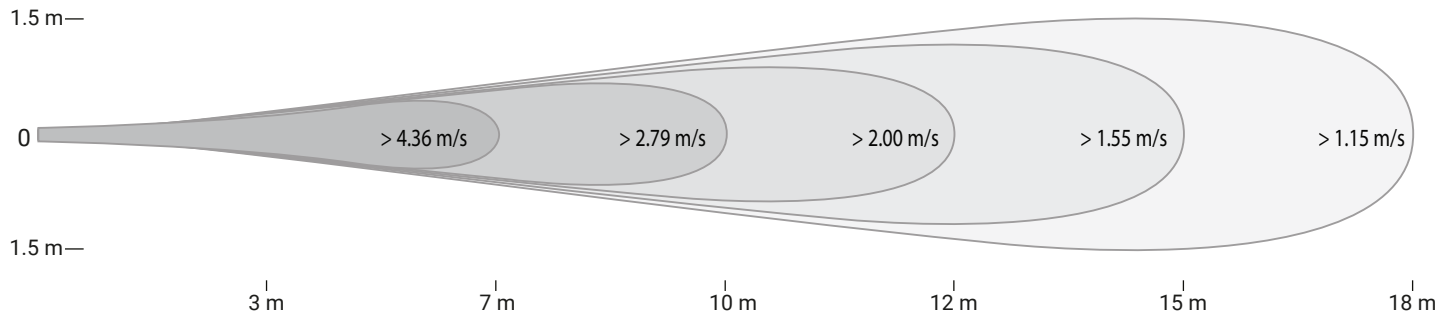

UNIT PLACEMENT

PREPARATION

Install electrical circuit(s) and outlet(s) in accordance with national and local electric codes.

Outlets should generally be mounted vertically unless a “twist/locking” type is being used.

Wall switch may be installed in circuit to disable power and prevent electrical hazards when servicing.

Confirm electrical continuity of Airius unit on the ground before permanently mounting in the ceiling.

MAINTENANCE

Frequency of cleaning will vary by application and environment.

You may clean the plastic housing with a damp warm cloth, using mild household detergents.

Do not use petroleum products, thinners or solvents to clean any part of the Airius unit.

If the Airius unit fails, contact manufacturer.

MATERIALS & PROPERTIES

Constructed from recyclable materials.

The outer shell, stator and fan blades are fire rated 5VA materials.

Power cord is a 1.8m, 3 wire, 1.02 mm diameter 300VAC rated electrical cord - CE/EU compliance rated as HO5VV (PLUG NOT SUPPLIED).

Electrically commutated, variable speed 92% efficient motor.

Motor is thermally protected. Shutoff is at 135°C & reset is at 125°C.

No lubrication required. Bearings are sealed.

OPERATION

Designed to operate 24 hours-a-day, 7 days-a-week to maintain air circulation/thermal equalization/humidity equalization.

Use optional speed control to fine tune RPM if needed.

INSTALLATION

Do not hard connect fans in excess of 10 kgs unless agreed with Airius prior to Installation. When attaching it is preferred if some chain or cable is used between fan and the support. However it is not imperative.

For Cooling the Airius fan should be located to suit client's requirements. Suggested locations are from just under the ceiling or closer to the floor to ensure suitable air-cooling flow.

For Heating or Conditioned Spaces the Airius fan should be securely installed as close as possible to the ceiling.

For combination applications fans can be installed close to ceiling or lowered slightly. Contact Airius for design details and assistance.

The Airius unit performs best when air column from the nozzle is unimpeded to the floor.

The Airius unit should not be mounted directly in front of heat ducts, vents or any other high heat source.

Use professionally installed hardware, capable of supporting a minimum of five times the weight of the fan unit.

Hardware to hang the unit includes but is not restricted to: Hooks, chains, cables, carabiners, bridle rings, beam clamps and bolts.

Density of the placement is directly related to the effectiveness, performance and savings.

Mount out of reach from people and animals.

Floor plans, mezzanines, office locations, machinery, people placement, plumbing, lighting, duct work, electrical systems, natural light/air systems, cranes, doors, windows, ventilation and fire suppression systems are all factors in properly locating the Airius system within the ceiling.

CHAIN HUNG (STRAIGHT)

PLUG NOT SUPPLIED

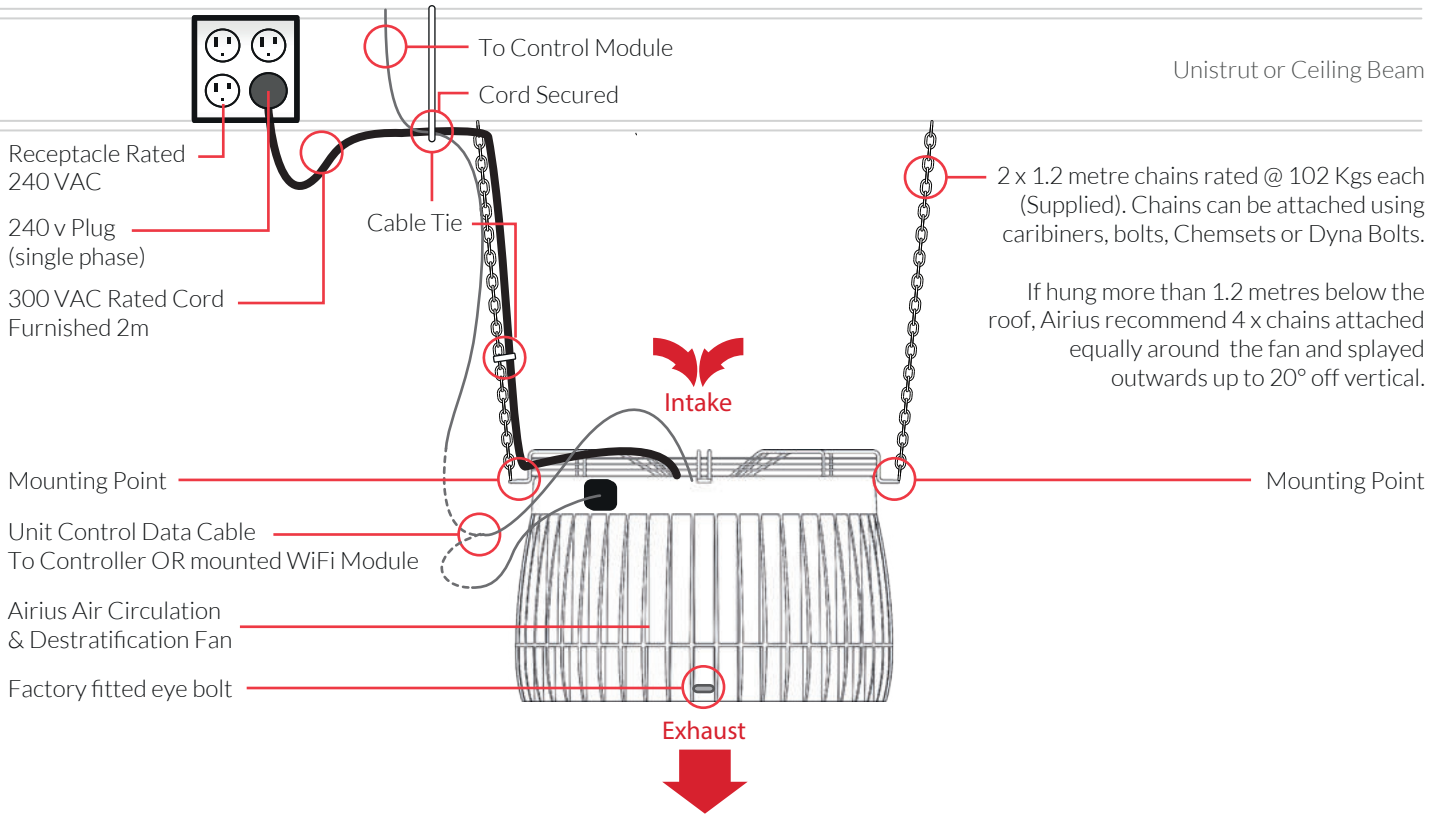

CEILING FIXED (STRAIGHT)

PLUG NOT SUPPLIED

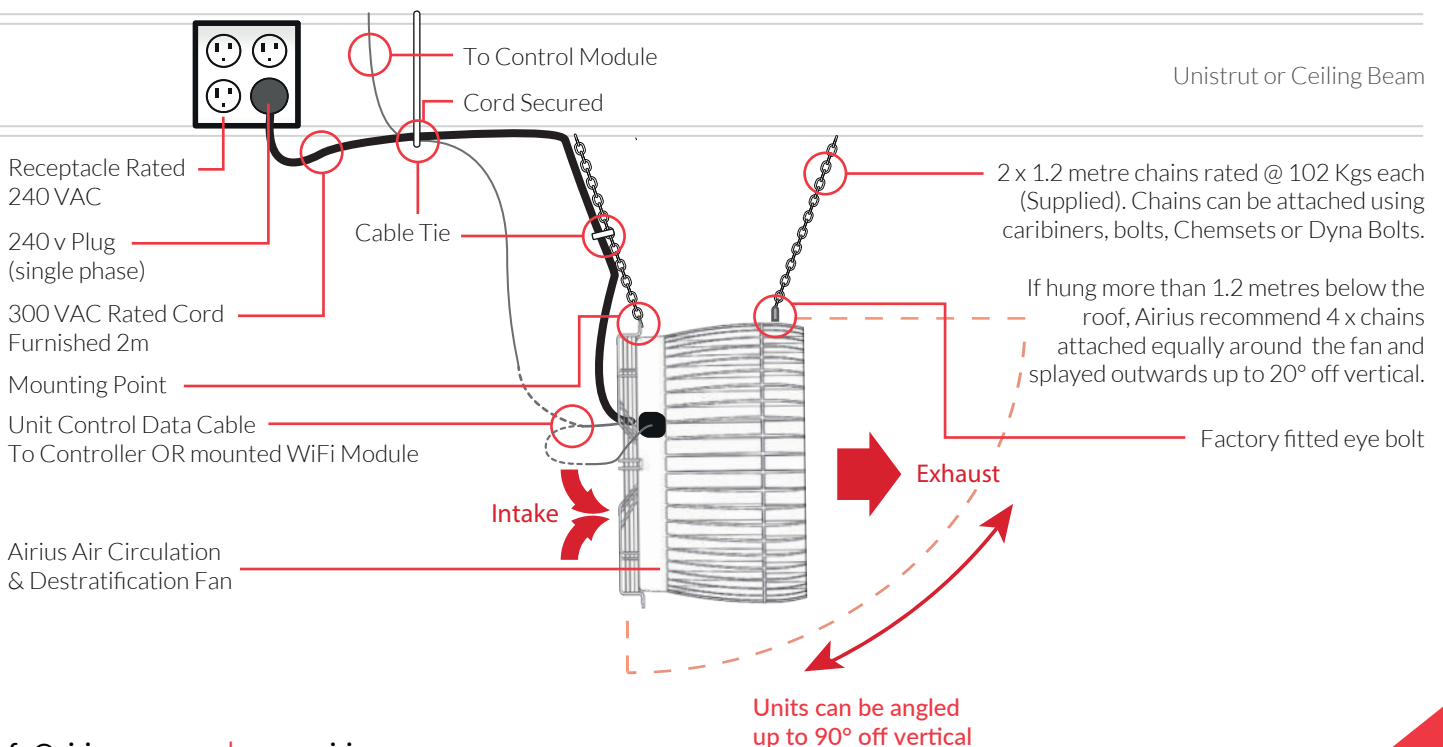

PEARLINK

Reduce installation cost & control your
Airius fan system over 2.4Ghz WiFi



DISTRIBUTED COMFORT

The PearLink control system offers total fan control from a desktop or mobile device. It integrates with existing Wi-Fi to provide wireless connectivity for monitoring air temperatures and stratification levels for cooling and heating applications and to provide individual or grouped fan control. This factory installed option will replace all control wiring and manual wall controls. Each installation can, at a small cost, include a floor sensor to be installed near your thermostat to monitor room temperature and stratification levels.

WHERE WE HELP

- » Reduce installation cost by eliminating control wiring
- » Control fans individually or in groups over 2.4Ghz WiFi
- » Provide fan control from anywhere in the world on your portable device or laptop

FEATURES

- » Interface is web-based (Chrome/Firefox), iOS, or Android
- » Monitor temperature and humidity at fan and floor level
- » Utilise temperature information to provide cooling air flow
- » Monitor Delta-T (stratification level)
- » Monitor fans via the integrated tachometer
- » Alerts for run time and/or stratification
- » Upgrade firmware via Over The Air (OTA) encrypted firmware updates

Housing: PC/ABS, Off white (cool gray 2c)

Mounting: Factory installed at time of ordering.

Power Consumption

Idle: 16mA
TX/RX: 200mA

Wi-Fi Characteristics

802.11b/g/n 2.4 GHz
TX Power 18 dBm @ 1DSSS
RX Sensitivity -96 dBm @ 1 DSSS
Range 100 meters

Sensors & Accuracy

Temperature Sensor +/- 0.5°C
Humidity Sensor +/- 1% RH
Tachometer +/- 3%

Interface

Web-based (Chrome/Firefox), iOS, or Android (Mobile apps available in App Store and Google Play Store)

Requirements

2.4 GHz Wi-Fi network
Phone or tablet with iOS 8 or later, or Android 4 or later required for setup
Browser for accessing the web dashboard to control devices (PC or MAC)
A free PearLink Account

Operating Conditions

Temperature 0 to 48.8°C
Humidity Up to 90% RH
Altitude Up to 3,300 mts

Ordering

The PearLink control is a factory installed option. Please refer to the individual model data sheets for configuring your fan.

Warranty

1 years parts and workmanship.



AIRIUS FAN SYSTEM



AIRIUS CONTROLS SERVER

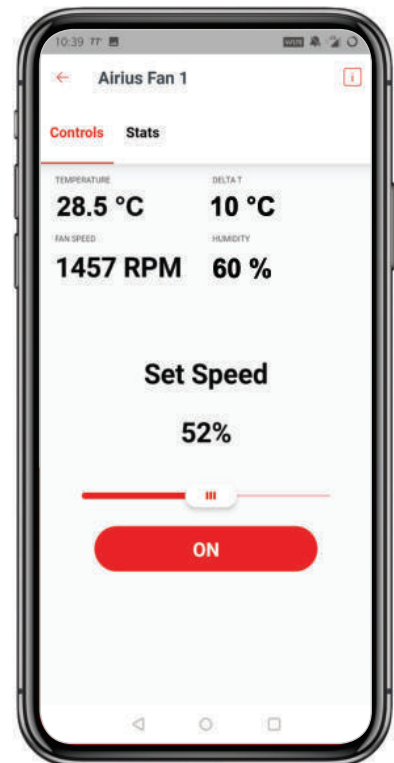

PHONE OR TABLET

PEARLINK

Quick Setup Guide

ACCOUNT CREATION

Once you have purchased your Airius Wi-Fi fans, simply download the free 'Pearlink Wireless Fan Control' app from the app store or visit <https://controls.airiusfans.com/dashboard/login> and create an account using your email address to log in.

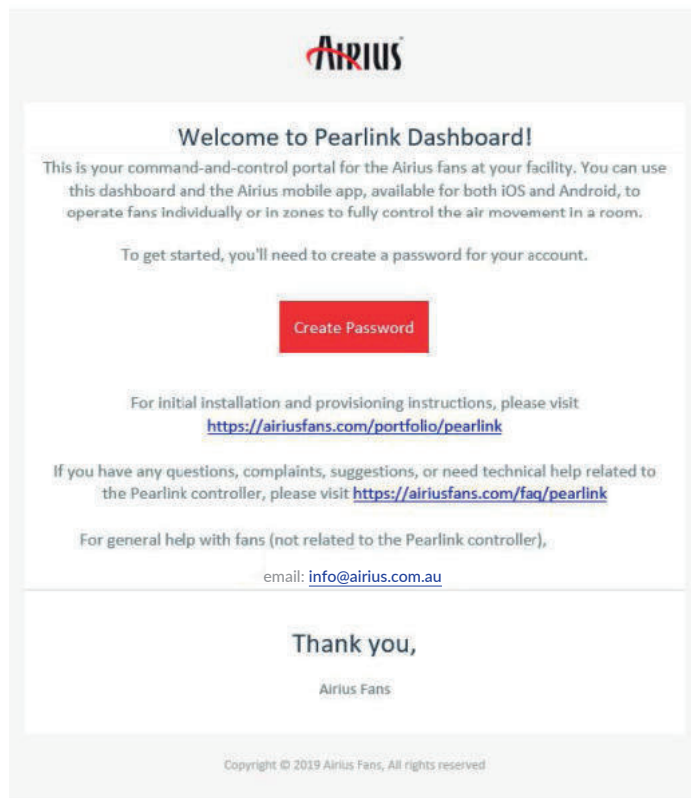

This is your command-and-control portal for the Airius fans at your facility. You can use the web based dashboard or the the Airius PearLink mobile app, available for both iOS and Android, to operate fans to fully control the air movement in a room.

What you will need before moving on:

- > Your Wi-Fi network name and associated password
- > Android, iOS device, laptop or desktop computer (for provisioning)
- > Height of each fan A.F.F. (above finished floor)

To begin, please download and install the Airius 'PearLink Wireless Fan Control' app, which can be found on the Google Play or Apple Stores, or visit:

- > <https://controls.airiusfans.com/dashboard/login>.

PROVISIONING DEVICES

The Airius fan system should be installed, powered and within Wi-Fi range along with the Android/iOS device used to provision the fans. The floor sensor should be located within the same space, connected to power using the small transformer supplied and installed 1.5-1.8 mts A.F.F. Preferably next to your existing thermostat.

Open the Airius App and enter your email address and password to log in. You are now ready to provision your devices.

Note: the screen shots are from an Android device and might vary slightly for iOS devices.

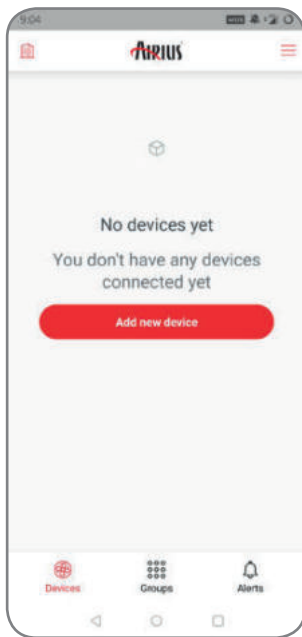

Press the "Add new device" button:

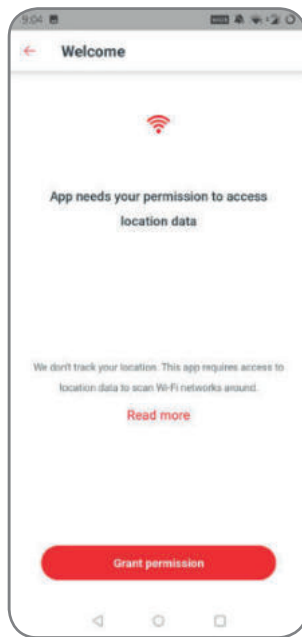

Grant Wi-Fi Permission

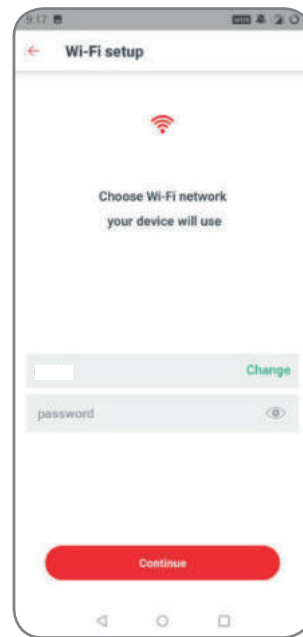

Enter your Wi-Fi credentials



Press the "Ready" button:

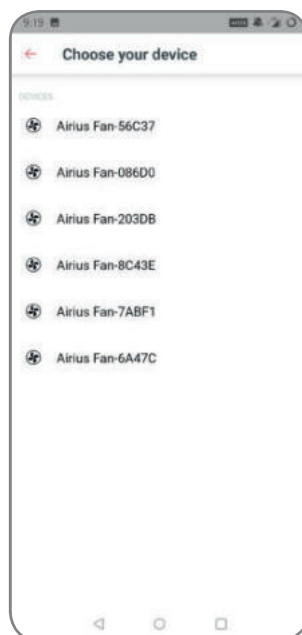

Choose your device. Provision all floor sensors before any fans.

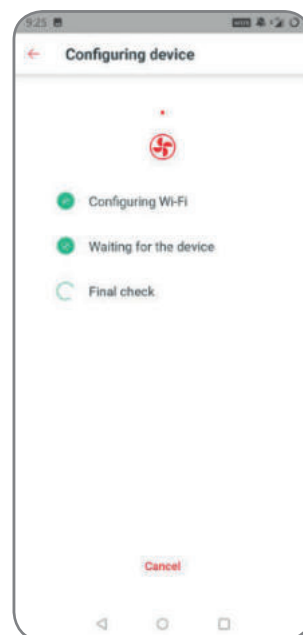

App will provision device



Name the device

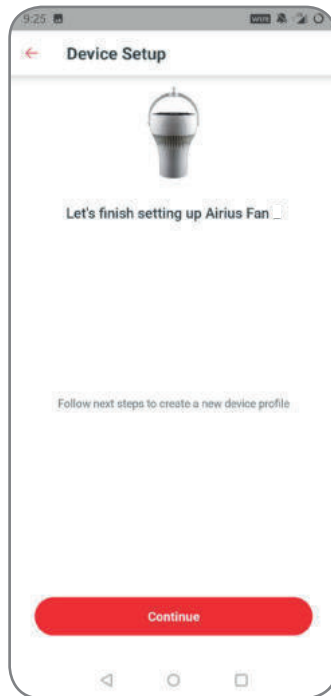

Continue

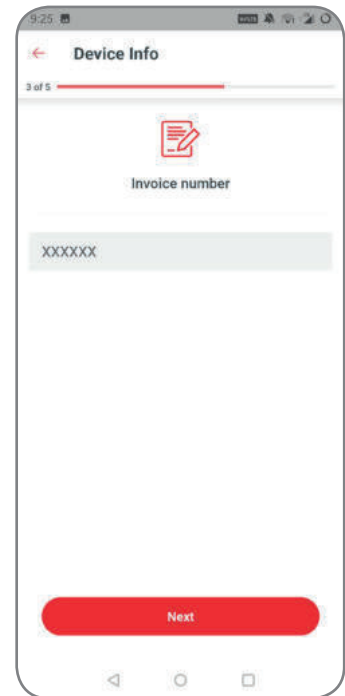

Enter the associated invoice number

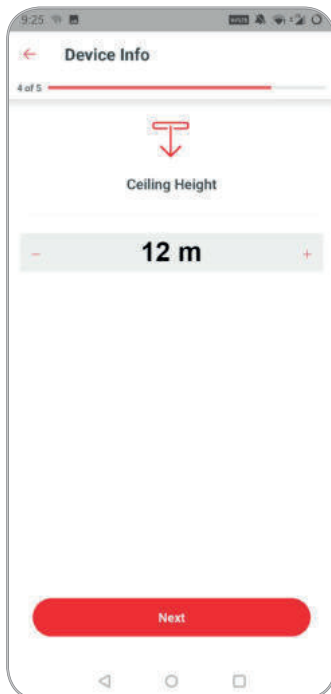

Enter the ceiling height where the fan is installed

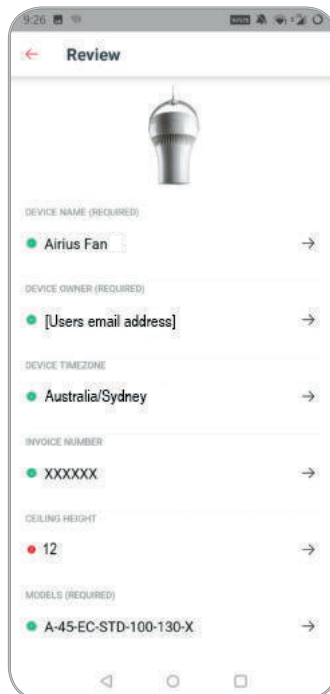

Review the information and select the correct fan model from the drop down menu

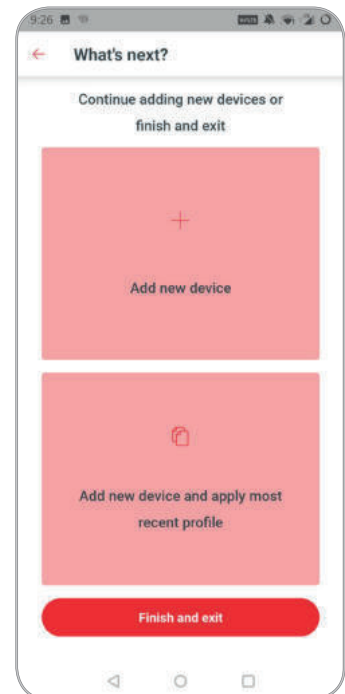

Select, "Add new device and apply most recent profile" > Follow the same steps for each device

DEVICE CONTROL

The PearLink app allows for individual and group fan control. PearLink will monitor the air temperature at the fan and at the floor to provide a delta temperature. The humidity and air temperature will be logged and viewed within the app. This data can be exported as a csv file.

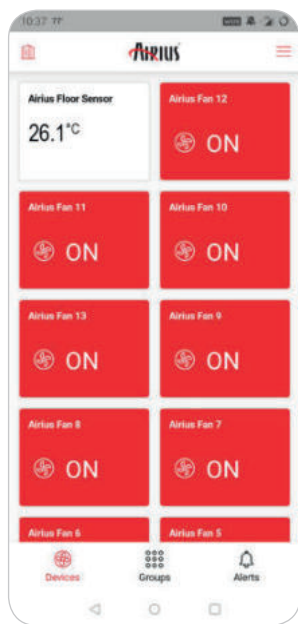

The device screen shows your device list. Press and hold will turn a device on/off. Pressing once will pull up the following screen for the specific device.

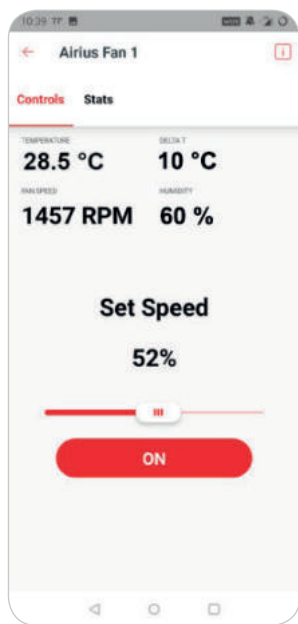

Individual device view. You can adjust individual fan speed, see the air temp/humidity at the fan and the rpm. Delta T = Fan temp - Floor sensor temp.



The stats tab shows temperature and humidity at the device over various periods of time. You can export this information as a csv from this view.

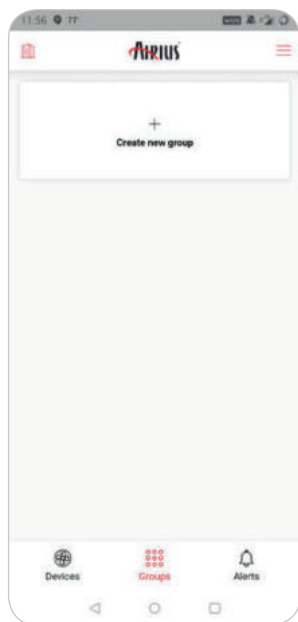

The group screen shows your fan/sensor groupings. Create a new group by pressing on the "Create new group" button.

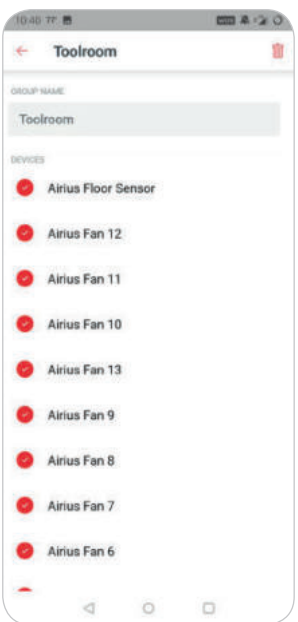

Name your group and select the devices you would like to add to this group. You now have the ability to control the fan speed of all devices within that group as well as on/off.

NETWORK MIGRATION

If you need to change your Wi-Fi network name or password for any reason, you must follow this process. If the name or password is changed before this step, the devices cannot be connected to. The only way to recover them is to revert back to the old network name and password. The following process will need to be repeated for all devices.

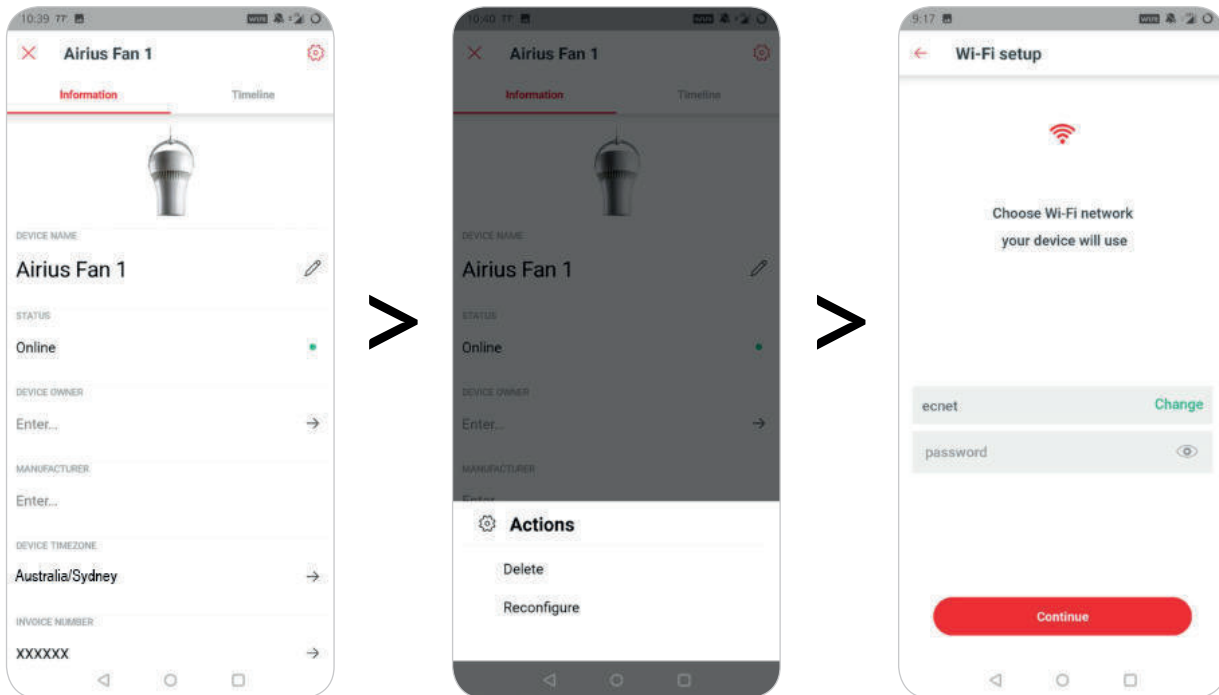

Under the individual device view, select the “i” icon then the gear icon in the upper right portion of the app.

Under “Actions” select “Reconfigure”

At this screen, you can enter the network name and/or password changes.

BMS CONTROL WIRING

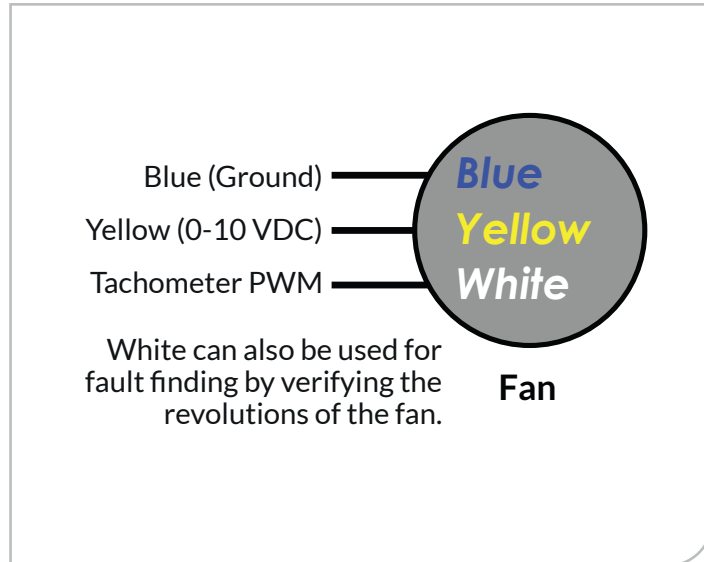

GENERAL NOTES

0-10 V signal allows infinitely variable open loop speed control

Connecting the red and yellow leads will allow EC fans to operate at full speed

A single controller can be used to control multiple fans with the same speed setting

The BMS generates this voltage to send to the signal (yellow)

Yellow is labelled as 0-10VDC because that is the acceptable range of voltages that the fan will accept

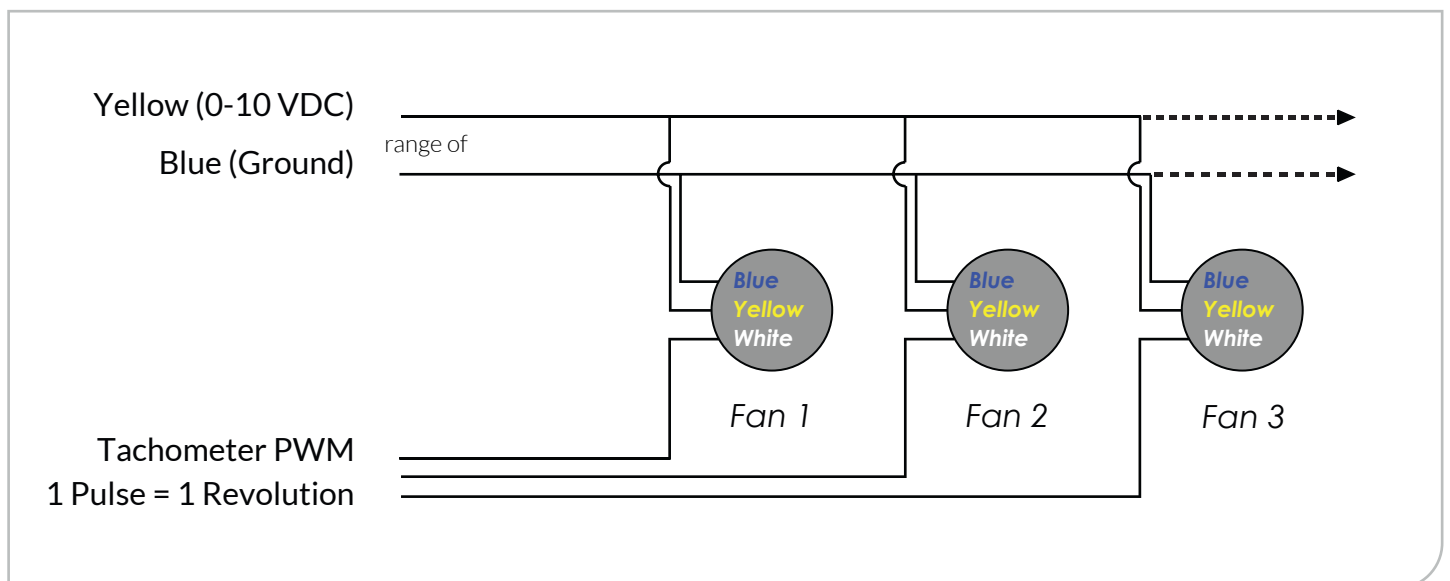

POTENTIOMETER EC (0-10V) NON-POWERED SPEED CONTROLLER



FEATURES

Input Voltage: 10VDC
Output Voltage: 0-10VDC

OPERATION

Rotating the dial will change the output voltage from 0VDC to 10VDC and change fan speed. The push button is used for on/off control.

The indicator light shows the on/off power status.

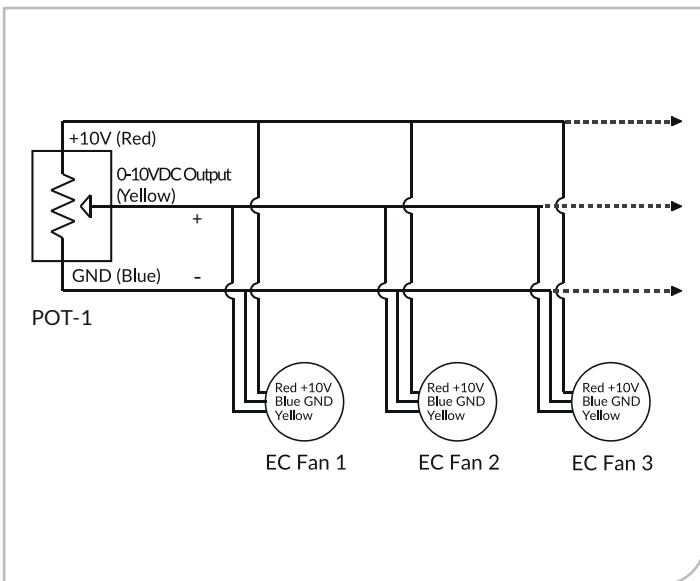

WIRING

1) Open the front panel by using a flat head screwdriver

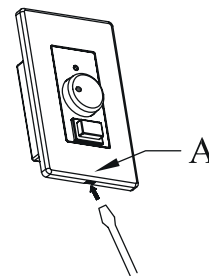

2) Wire according to the diagram on the previous page

3) Install the front panel as shown in the following diagram

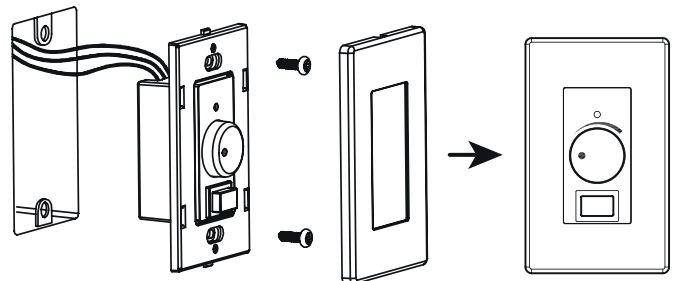

CAUTION

Electrical installations should only be carried out by qualified personnel only. Follow safety measures to avoid electric shock.



TOUCH SCREEN EC FAN CONTROLLER



SPECIFICATIONS

Operating voltage	24V DC ONLY (By Others)
Mounting	Surface mount backbox option
Display	3.5" Resistive touch-screen 320x240 pixel resolution 65k colours
Operating Temp	5..50oC
Storage Temp	-25..+75oC
Relative Humidity	%5..95 rh, non-condensing
Weight	165gr (225 gr with packaging)
Protection	IP30 according to EN 60529
Connections	Screw terminals, max 1 mm ² (26-16 AWG)
Programming Port	Standard Micro USB cable

PIN CODE

Touch Screen Pin Code: 2474
 Device Addressing Menu Pin Code: 7913

CONTROLLER DESCRIPTION

Overview

The Airius Touch Screen Controller is a programmable room controller ideal for managing Airius EC fans.

The unit has no on-board inputs & outputs, but is able to connect to a multitude of external IO, due to multiple communication ports and protocols. Integrated temperature sensor is standard.

Display / User Interface

3.5" resistive color touch-screen. 65K colors.

Powered by SEDONA Framework

The Sedona Framework™ provides a complete software platform for developing, deploying, integrating, and managing pervasive device applications at the lowest level.

It brings the power of programmable control and the Internet down to extremely inexpensive devices.

The Sedona Framework distributes decision making control and manageability to any device and brings intelligence and connectivity to the network edge and back.

INPUT OUTPUT MODULE FOR AIRIUS TOUCH SCREEN CONTROLLER

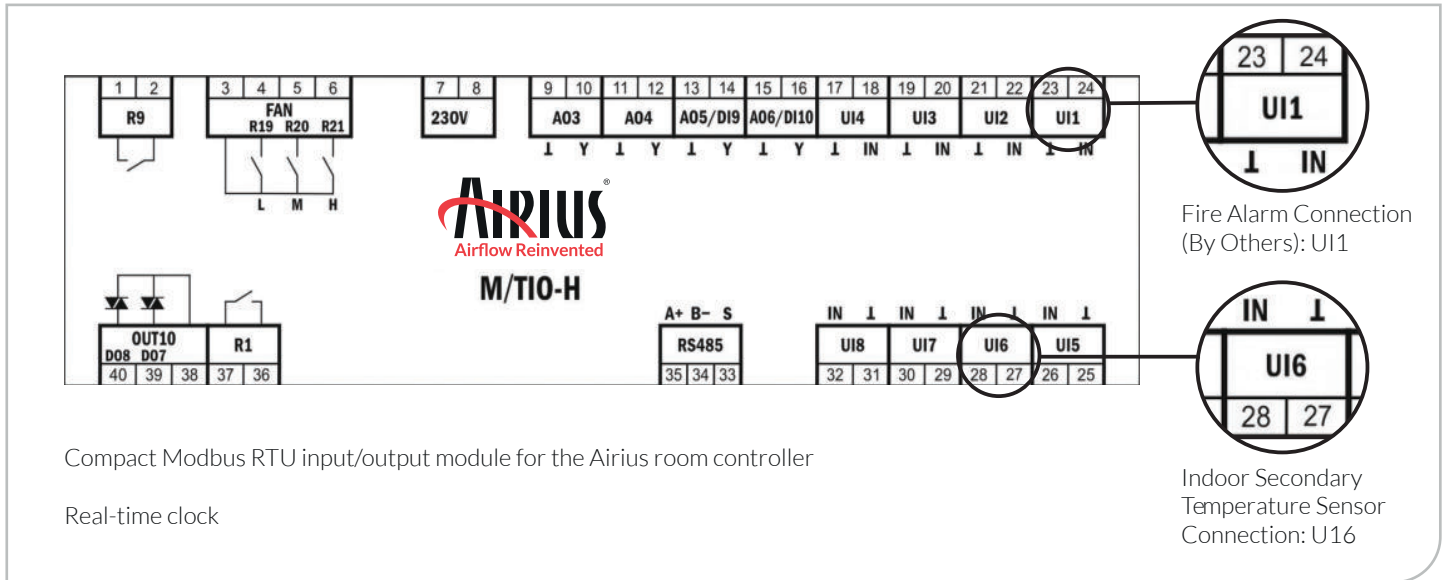

SPECIFICATIONS

Operating voltage	230V VAC +10% -5%, 50/60Hz
Power Consumption	Max 3.5 VA (including Airius touch screen, excluding field devices)
Operating Temp	5..50oC
Storage Temp	-25..+75oC
Weight (net/gross)	400 gr / 530 gr 750 gr / 890 gr (aux. 24V DC output versions)
Dimensions	158 x 86 x 60 mm
Installation	Standard 35 mm rail mount
Protection	IP30 according to EN 60529
Connections	Screw terminals, max 1.5 mm ² (AWG 16)
Universal Inputs	8 inputs (see table for sensor signal compatibility)
Relay Output	4 Relays, 230 V DC / 5A 1 Relay, 230 V DC / 10A
Triac Outputs	2 Triacs, 0.1A@230V DC 0.5A@24V DC
Modulating Outputs	4 outputs 0(2)-10 VDC, 2mA max (2 configurable as digital in)
Expansion Port	Ribbon cable connection to max 2 relay module (RK4)

DIMENSIONS

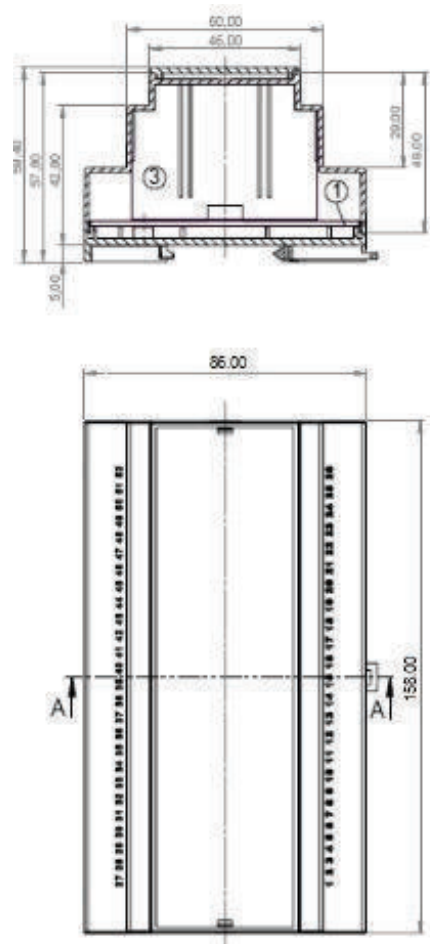

CONNECTIONS

M/TIO DESCRIPTION

General

M/TIO modules provide a compact input/output solution for Modbus RTU master controllers.

The unit has incredibly flexible input / output configuration that allows many applications to be controlled by a single device.

A combination with any Modbus wall unit greatly simplifies installation on the wall-unit side, as the IO module can be located close to the terminal unit being controlled, with only communication wiring into the wall unit. The mains powered versions eliminate the need for additional power supplies or transformers further reducing cost and installation labor.

M/TIO also hosts a battery backed-up real-time-clock..

Relay Outputs

5 relay outputs are provided. Each relay can be used independently, and a specific set of three can be configured for 3-speed fan control.

Universal Inputs

8 inputs are provided, configurable as below:

	Pt1000	NTC	0-19 VDC	Voltage Free Contact
In 1		✓		✓
In 2		✓		✓
In 3		✓		✓
In 4		✓		✓
In 5	✓			✓
In 6	✓		✓	✓
In 7	✓		✓	✓
In 8	✓		✓	✓

Triac Outputs

2 triac outputs are provided with flexible configuration options, allowing control of on/off thermoelectric (PWM) or floating actuators or relays. The triacs can be independently configured to control different loads. However, due to internal connections, all loads must be supplied from the same AC voltage. Floating (three-position) configuration requires use of both triacs.

Modulating Outputs

Four 0-10VDC analog outputs are provided for controlling modulating valve or damper actuators. Two of these can be configured to function as digital inputs.

Expansion Port

Up to two RK4 modules can be connected to the device with a ribbon cable, providing a total of 8 additional relay outputs

Real Time Clock

4 time-schedules can each be independently associated with a relay output through configuration parameters. Each schedule allows 28 sets of start/stop times per day of the week.

WIRING DIAGRAM - 4 OR 8 FANS OR GROUPS OF

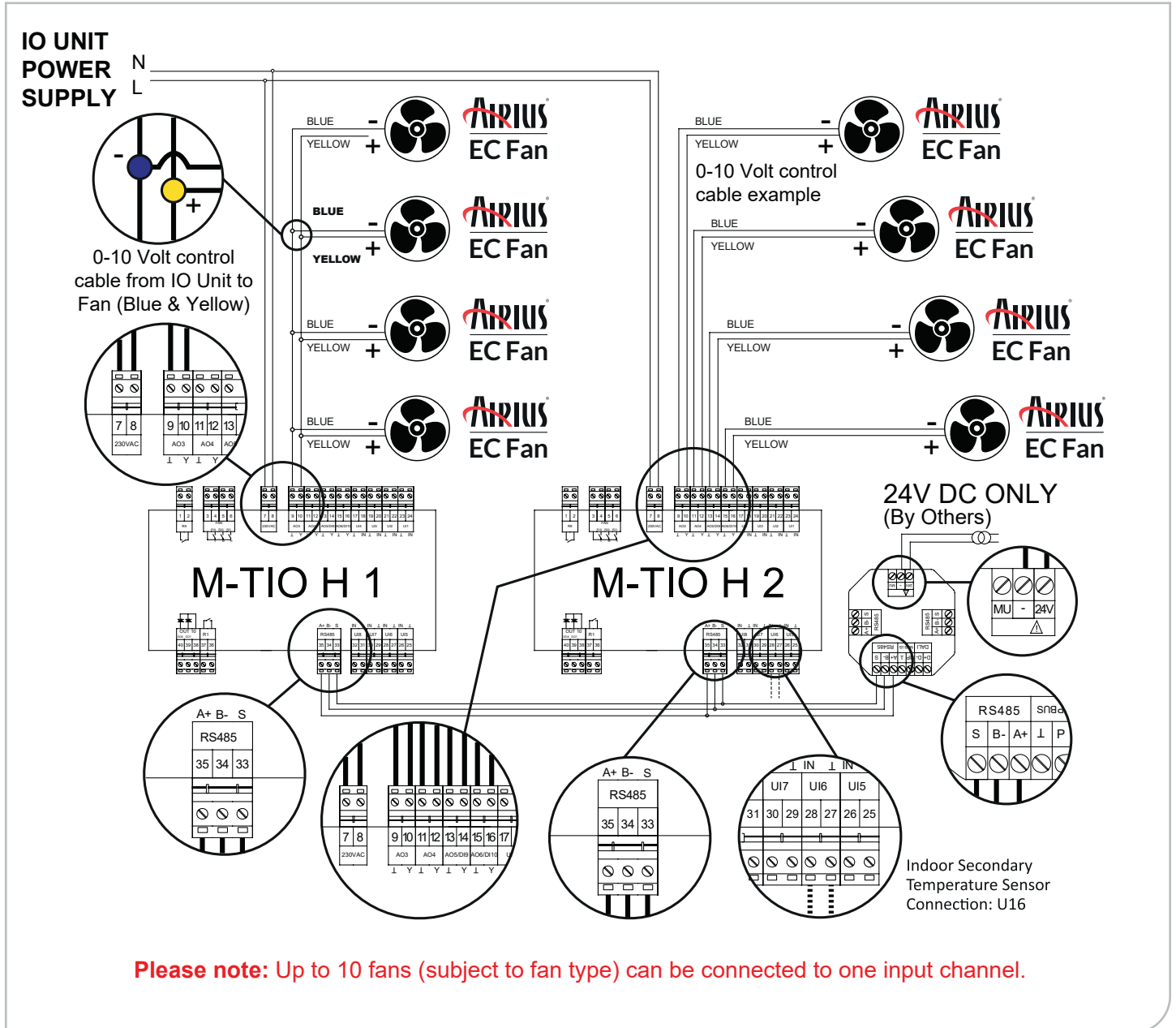

NOTE: When using more than four fan Zones (an 8 zone touch screen) 2 x MTIOH units need to be connected to the touch screen as per below details; The MTIOH units must be addressed correctly.

Fan zones 1-4 use -ADDR-1 (maybe noted on MTIO unit) or MTIO-1 as per the graphics below and for zones 5-8 MTIO-2 (maybe noted on MTIO as ADDR-2). These are supplied pre-addressed but the addressing can also be changed on the touch screen using the manufacturer supplied higher level pin code.

AIRIUS TOUCH SCREEN CONTROLLER WITH FIRE ALARM INPUT (BY OTHERS) AND EXT TEMP SENSOR - 8 FANS

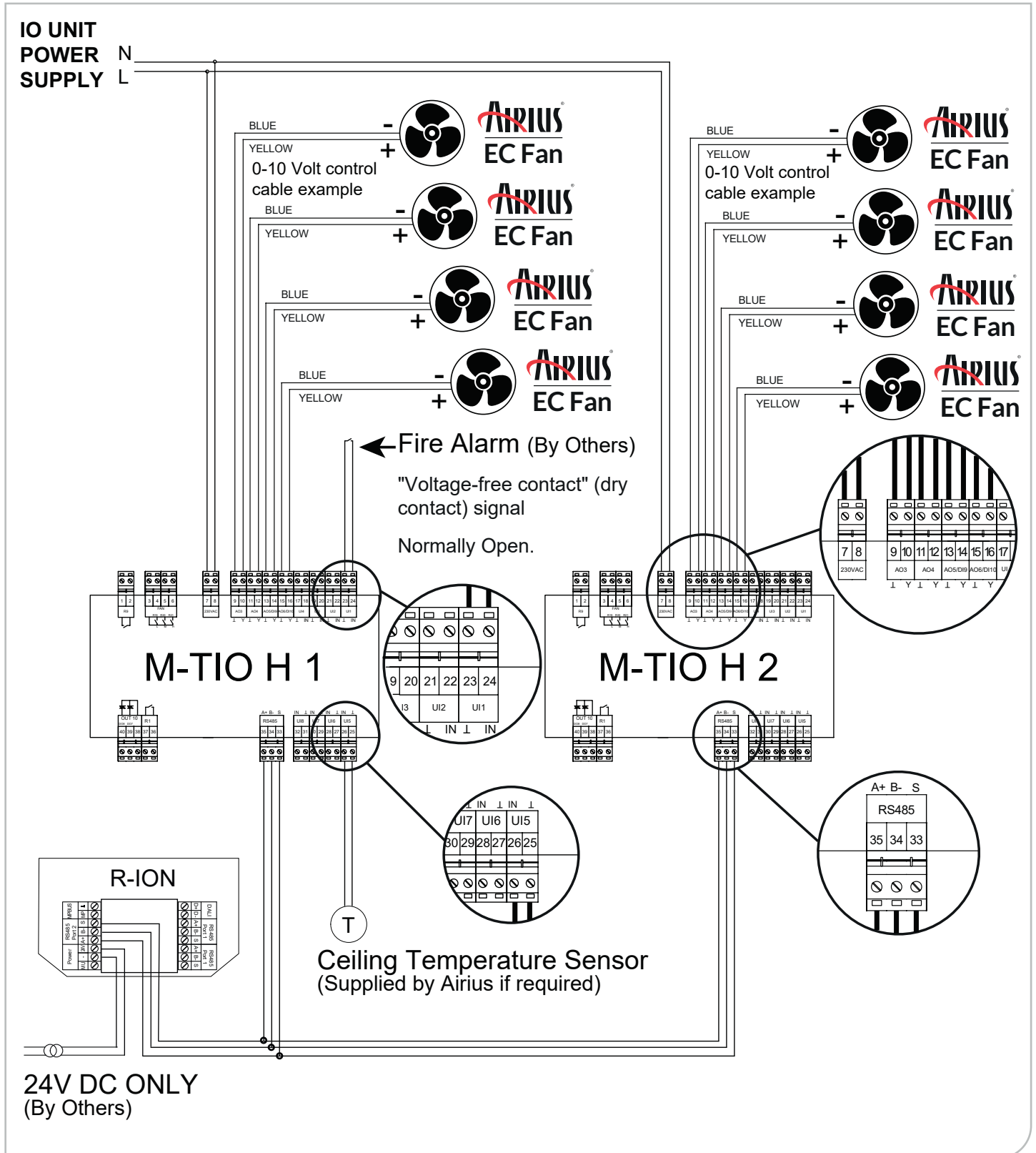

STANDARD WALL BOX INSTALLATION

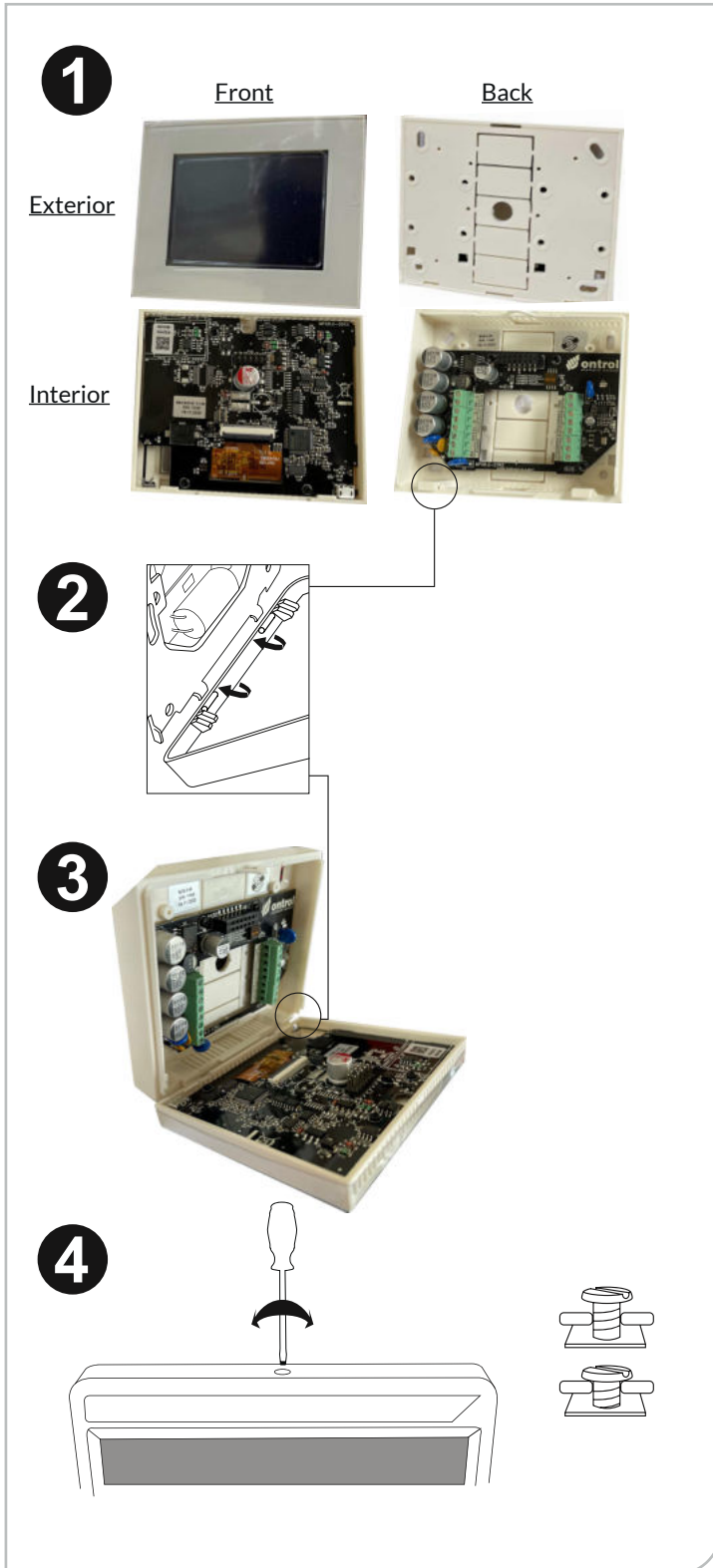

Fit base unit in flush-mounted box.
Fasten metal frame to wall box with two screws*.

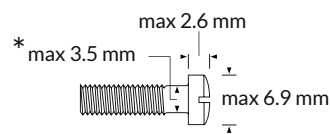

Fit display unit's bottom side on the metal frame's hinges.

Rotate display unit up on to the base unit, making sure connection pins are aligned.

Tighten captive top screw with small screw-driver.



When removing display part

- Make sure to untighten the top fixing screw
- Pull only from the top, with two fingers on the sides
- Do not apply excessive force

INSTALLATION TIPS

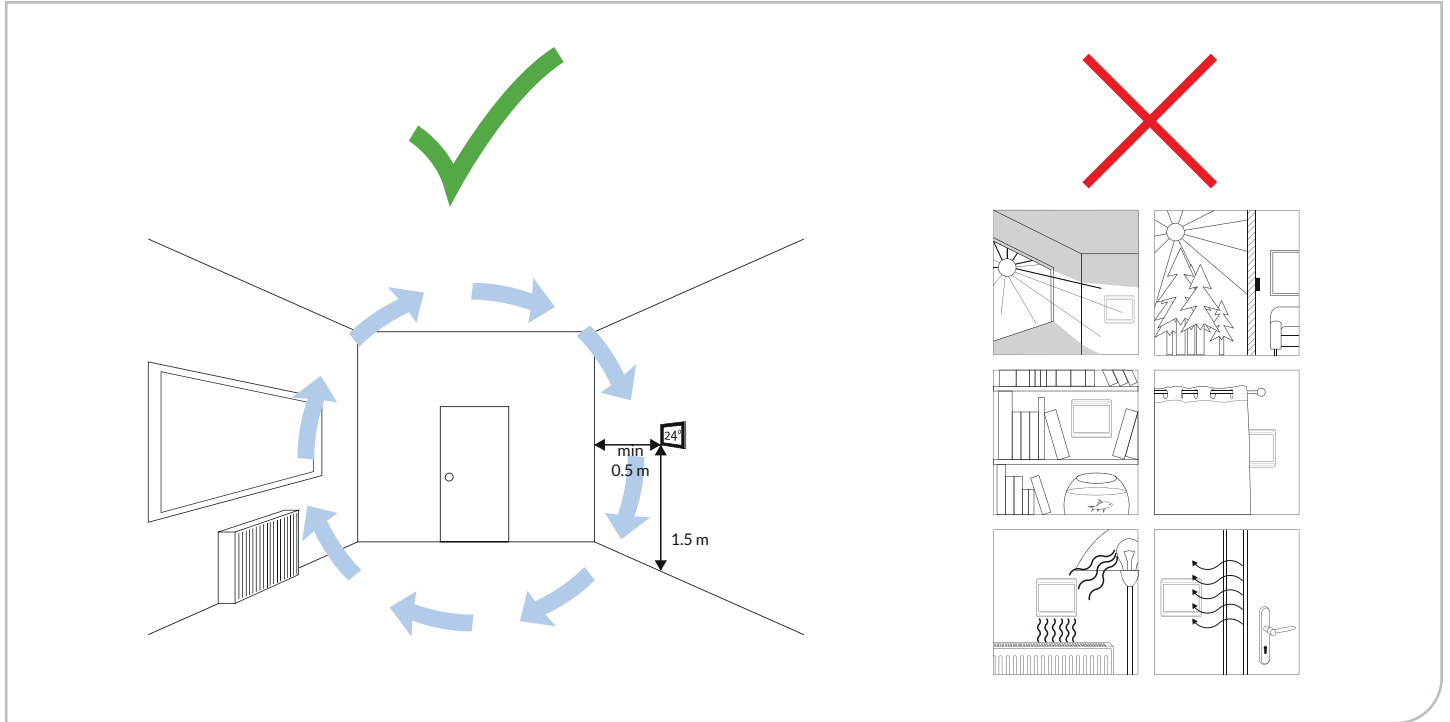



AIRIUS[®]

Airius (Oceania) Pty Ltd

P.O. Box 1812, Byron Bay, NSW 2481

info@airius.co.au

www.airius.com.au